

# Notifact<sup>®</sup> GSM Models

## INSTALLATION & OPERATING INSTRUCTIONS

PROTECTED BY U.S. PATENT NO. 6,147,601, U.S. PATENT NO. 6,160,477, U.S. PATENT NO. 6,211,782 AND OTHER PATENTS PENDING

**THANK YOU** for purchasing the Notifact wireless monitoring system. You've joined the Notifact revolution! A key element of your Notifact system is the transmitter to be mounted on or near the equipment you are monitoring.

Various transmitter models are available for specific types of equipment such as air conditioners, boilers, or pumps. Each model is equipped to generate messages based on eight inputs or on information from a communication port on certain equipment. Some models also provide information on equipment run times. In general, Notifact can monitor any system which has switch or AC voltage inputs or outputs.



Typical messages might include:

- Compressor pressure out of range
- Condensate levels out of range
- Air flow (or lack of flow)
- Boiler lockout
- Boiler low water cutoff
- Freeze conditions
- Temperature out of range
- Pressure out of range
- Float switches reading either a high level or a low level (or both)
- Equipment was opened or tampered with
- Equipment power was lost

At the Notifact web site, the user configures which individuals will receive a message regarding certain operating conditions and the delivery method. Delivery methods include pagers (alphanumeric, numeric), fax, e-mail, XML email, PCS or telephone (voice delivery). Each message sent will contain the condition which generated the transmission, and also make, model, and location of the equipment.

The transmitter is powered by the equipment power source and constantly monitors the inputs. When an input is triggered, the transmitter sends the condition over the GSM cellular System. The transmission is received at the Notifact messaging center and is forwarded to the selected message recipients by the configured delivery method.

Every 24 hours, the transmitter will also send information about itself and the system it is monitoring. This transmission tells the Notifact center that the transmitter is properly functioning, powered, and able to generate messages. Some models report equipment run times and the number of cycles in the last 24 hours. If a device fails to report a nightly heartbeat for more than a day, you will be notified by a "Unit Failed to Report Heartbeat" alarm message.

# Table of Contents

<b>Important Safety and Product Information .....</b>	<b>3</b>
<b>Setting Up Your NOTIFACT Account .....</b>	<b>4</b>
Access the Notifact Web Page .....	4
New Account Setup .....	4
Credit Application .....	5
<b>Using The On-Line Messaging System .....</b>	<b>6</b>
Access the Notifact Web Page .....	6
Logging In .....	6
<b>Installing A Device On Website .....</b>	<b>7</b>
Input Device ID Number .....	7
Message Delivery .....	9
Types of Users .....	10
Transmitter is now included in the Device Summary .....	12
Change Status .....	12
<b>Configuring &amp; Editing Device Messaging .....</b>	<b>12</b>
Device Messages .....	12
Message Information .....	12
Custom Messages .....	14
Edit Delivery Detail .....	14
View Last Message Summary .....	16
Last Message Summary Sort Screen: .....	16
Manage All Deliveries .....	16
De-Activating Your NOTIFACT Device .....	18
Hardware Configuration .....	19
Re-Activating Your NOTIFACT Device .....	19
Reactivation Waiting Period .....	19
<b>Installation .....</b>	<b>22</b>
Connecting a Remote Antenna .....	22
Startup Procedure .....	23
Checking Cell Coverage .....	23
Location .....	23
Mounting .....	24
Record Equipment Information .....	24
Testing .....	24
Check the Transmitter .....	25
Check the messages .....	25
<b>NOTIFACT System Check List.....</b>	<b>26</b>
<b>Notes.....</b>	<b>27</b>

# Important Safety and Product Information

- 1. THESE PRODUCTS, AND THE ACCOMPANYING MONITORING SERVICES, ARE NOT SUITABLE FOR USE, AND ARE NOT INTENDED TO BE USED, FOR FIRE OR SMOKE DETECTION, SECURITY, EMERGENCY OR LIFE SUPPORT APPLICATIONS.**
- 2. UNLESS SOLD PURSUANT TO OTHER WRITTEN AGREEMENT(S) ENTERED INTO BY AND BETWEEN NOTIFACT AND THE USER OF THESE PRODUCTS AND THE ACCOMPANYING MONITORING SERVICES, IN WHICH CASE SUCH USE OF THESE PRODUCTS AND THE ACCOMPANYING MONITORING SERVICES ARE GOVERNED BY SUCH WRITTEN AGREEMENT(S), ALL USE OF THESE PRODUCTS(S) ARE SUBJECT TO THE NOTIFACT STANDARD TERMS AND CONDITIONS OF SALE AND NOTIFACT MONITORING SERVICES TERMS AND CONDITIONS . USE OF THE PRODUCTS CONSTITUTES ACCEPTANCE OF SUCH TERMS UNLESS OTHERWISE AGREED TO BY NOTIFACT.**
- 3. BECAUSE OF THE VARIETY OF USES FOR THESE PRODUCTS, THOSE RESPONSIBLE FOR THE INSTALLATION, APPLICATION AND USE OF THESE PRODUCTS MUST DETERMINE FOR THEMSELVES THAT ALL NECESSARY STEPS HAVE BEEN TAKEN TO ASSURE THAT EACH APPLICATION AND USE MEETS ALL PERFORMANCE AND SAFETY REQUIREMENTS, INCLUDING ANY APPLICABLE LAWS, REGULATIONS, CODES AND STANDARDS. NOTIFACT EXPRESSLY DISCLAIMS ANY WARRANTY OF FITNESS FOR A PARTICULAR PURPOSE WITH RESPECT TO PARTICULAR APPLICATIONS FOR WHICH A USER MAY USE THE PRODUCTS.**
- 4. THE ILLUSTRATIONS, CHARTS AND LAYOUT EXAMPLES SHOWN IN THIS INSTALLATION MANUAL ARE INTENDED SOLELY FOR PURPOSES OF EXAMPLE. BECAUSE THERE ARE MANY VARIABLES AND REQUIREMENTS ASSOCIATED WITH ANY PARTICULAR INSTALLATION OR USE OF THE PRODUCTS, NOTIFACT DOES NOT ASSUME RESPONSIBILITY OR LIABILITY (TO INCLUDE INTELLECTUAL PROPERTY LIABILITY) FOR ACTUAL USE BASED ON EXAMPLES SHOWN IN THIS INSTALLATION MANUAL.**

***Warning: Changes or modifications to this unit not expressly approved by the party responsible for compliance could void the user's authority to operate the equipment.***

*NOTE: This equipment has been tested and found to comply with the limits for a Class A digital device, pursuant to Part 15 of FCC Rules. These limits are designed to provide reasonable protection against harmful interference when the equipment is operated in a commercial environment. This equipment generates, uses, and can radiate radio frequency energy and, if not installed and used in accordance with the instruction manual, may cause harmful interference to radio communications. Operation of this equipment in a residential area is likely to cause harmful interference in which case the user will be required to correct the interference at his own expense.*

THESE PRODUCTS ARE NOT SUITABLE FOR USE, AND ARE NOT INTENDED TO BE USED, FOR FIRE OR SMOKE DETECTION, SECURITY, EMERGENCY OR LIFE SUPPORT APPLICATIONS.

THESE PRODUCTS ARE INTENDED TO BE INSTALLED BY PROFESSIONAL INSTALLERS ONLY.

NOTIFACT DISCLAIMS ANY LIABILITY FOR DAMAGES CAUSED BY INCORRECT INSTALLATION OR IMPROPER USE OF THESE PRODUCTS.

COPYRIGHT © 2007 BY NOTIFACT. ALL RIGHTS RESERVED

# Setting Up Your NOTIFACT Account

To configure a transmitter, it is necessary to have a Notifact Account which will contain the billing information for the transmitter. If you have a User ID and Password, skip this section and proceed to page 23. It is recommended that the Notifact Device be configured on the WS prior to physical installation.

## Access the Notifact Web Page

- The Notifact web page can be found at [www.notifact.com](http://www.notifact.com).
- A copy of the home page is shown below.
- Note that any time you want to return to the home page just click on the Notifact logo in the upper left.
- Click on the menu item *Open an Account*.

Patents Pending

Notifact®  
Global Leader in Wireless Monitoring

**System Information**  
About Notifact  
Product Description  
Coverage Map  
Applications  
Literature  
System Demo  
Contact Us

**News at Notifact**  
News Releases  
Jobs at Notifact  
Trade Shows

**Notifact e-Partners**  
Become an e-Partner  
Service Contractors  
Facility Support  
Equip. Manufacturers  
Manufacturers Reps.  
Power Generation

**Online Shopping**  
Go Shopping  
Open an Account  
Pricing & Terms

Member Id:   
Password:   
• Submit • Reset

## New Account Setup

- The *New Account Setup* screen (pg. 5) allows you to set up your Notifact account.
- The information on this screen refers to the address where you will receive invoices for the Notifact service. Do not use this screen to input the information on where the User, or where the transmitter, will be located.
- Once you have filled in all the required fields, click on the *Submit* button.
- Your credit account must be approved before you can install a device.

## Credit Application

- The Notifact service will be billed monthly. Establishing a credit line will simplify this billing. Also, having a credit line will enable you to purchase Notifact transmitters on account.
- To bypass the credit application you may purchase devices and monitoring service with a credit card. Contact Customer Service for more information.
- If you wish to establish a credit line now, fill out the *Credit Application* form and press the *Submit* button.
- You may also print out the form and fax it to Notifact at (800) 504-0750. If you prefer to do this, click on the button *Fill In Credit Application Later*.
- You will receive a message thanking you for filling out the account information.
- Once your information has been verified, you will receive a User ID and password via e-mail.
- Be sure to record your Notifact User ID and password. *For security purposes, you will not be able to check this information at the web site in the future.*
- Your password can be changed at anytime by clicking on *User Information* tab..

Click on the logo at any time to return to this home page

**Notifact**

**Open an Account**

**Step 1:** Fill in the information below to receive a Member ID that will enable you to login to our website to install and configure devices.

**Step 2:** Choose your own password. Please choose wisely as you would need it every time you login into website.

**Step 3:** If you are planning to install Notifact devices and purchase monitoring services, please check appropriate checkbox at the bottom of this page.

Please note that you will not be able to install a Notifact device until Notifact has approved your credit account. Please remember that you will have an opportunity to submit credit references at any time in the future.

Company Name

First Name

Middle Initial

Last Name

Street Address

Address(cont)

City

State/Province

Zip/Postal Code

Email

Phone

Fax

Pager

Modem

XML

Website Address

Type of Business

Time Zone

Sales Rep.

Daylight Savings  check if device location follows daylight savings

Password  up to 10 characters

Retype password

Do you want to fill credit references?  check if you plan to install devices

**- required field**

This address is the billing address of the Account Holder

This information is to contact the Account Holder. This is not where messages will be sent

# Using The On-Line Messaging System

If you have received a Notifact User ID and password, continue with the steps below to configure transmitter messages. If you have not, either contact the Notifact Account holder to receive your User ID and password, or follow the steps on page 4 to set up a Notifact Account.

## Access the Notifact Web Page

- The Notifact web page can be found at [www.notifact.com](http://www.notifact.com).
- A copy of the home screen is shown below.
- Note that any time you want to return to the home page just click on the Notifact logo in the upper left.

## Logging In

- Fill in the assigned User ID and Password. These are encrypted for security purposes.
- Click on the *Submit* link.



- When you have successfully logged in, you can view installed devices in the *View and Edit Device* screen (see below).
- If you have any installed transmitters or transmitters that have been assigned to you, they will appear in a list.
- To add your new device, click on the *Install New Device* menu tab (see below).



**There are no devices installed.**

**Any previously configured transmitters would be listed here**

Copyright © 2002 Notifact®. All Rights Reserved.

Protected by U.S. Patent No. 6,147,601, No. 6,160,477, No. 6,211,782. Other patents pending.

"Notifact" is a registered trademark of Notifact Corporation. [Terms of Use.](#)

## Installing A Device On Website

### Input Device ID Number

- Before you can enter *Install New Device*, you must know its ID number.
- The ID number for the transmitter is on a label on the radio and also printed on the INSTALLATION EQUIPMENT INFORMATION card which was provided with the unit.
- Click on INSTALL NEW DEVICE and enter the ID Number.
- Enter the ID number and click the *Submit* button (as shown below).

Click here to Install a New Device

View & Edit Devices   **Install New Device**   Last Message Summary   Manage All Deliveries   User Information   Credit References

The purpose of this form is to verify that the Device ID you are entering is valid.

Device ID  

The Device ID is on the transmitter and on the Monitored Equipment ID Card provided

**Submit**   **Go Back**

Click here after entering the Device's ID number

## New Equipment Location

- The *New Equipment Location* screen (see below) refers to the equipment this transmitter is monitoring. If there are multiple pieces of equipment with transmitters in a single location, the information supplied should be sufficient to identify this particular piece of equipment from any others.
- All the information should be recorded on the MONITORED EQUIPMENT I.D. CARD provided with each transmitter.
- All the fields marked with check boxes are required.
- Do not use abbreviations such as St for Street or Rd for Road if you plan to use the voice message delivery.
- Do not use uppercase letters for words if you plan to use voice message delivery (example - use “flow” not “FLOW”) as the synthesized voice will announce the letters not the word.
- The address fields should have the address where the transmitter is installed.
- The contact information should contain the name and phone number of the individual(s) who can provide access to the particular piece of equipment.
- The bottom four fields identify the equipment. It is important to get as much information about the equipment being monitored as possible. The information should be sufficient so a service person can get any appropriate parts for

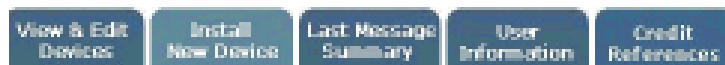

The purpose of this form is to identify the location of the equipment being monitored and its type.

- Location Name: This field may be used to help identify a piece of equipment for example Joe's Pizzeria or ABC Appliance RTU-3
- Address information can be used for dispatch and equipment logs.
- Local Contact name and phone number are helpful if it is necessary to call ahead for a key or access.
- Enter Time Zone where equipment is located in order to properly time stamp messages.
- Equipment Information can be used to identify required replacement parts

Please provide the following device location information. This information will be used to identify where a piece of equipment is installed when a message is sent

Device Id	97	
Model number	Model GN-1	
Location Name	<input type="text"/>	<p>Be as specific as possible</p>
Street address	<input type="text"/>	
Address (cont.)	<input type="text"/>	
City	<input type="text"/>	
State/Province	State <input type="text"/>	
Zip/Postal code	<input type="text"/>	
Local Contact Person	<input type="text"/>	
Local Contact Phone	<input type="text"/>	
Time Zone	Time zone <input type="text"/>	
Daylight Savings	<input type="checkbox"/> check if device location follows daylight savings	

- Required field

Please provide the following information about the equipment being monitored. This information will be helpful when replacement parts are needed for repair i.e. filters, belts, gas valve, ignition module.

Equipment Name	<input type="text"/>
Make	<input type="text"/>
Model	<input type="text"/>
Serial number	<input type="text"/>

This information should be complete enough to allow a service person to get the appropriate parts before coming to the equipment site

Click here when you have completed the form

## Message Delivery

- The default information entered in the *Edit User Info* screen will appear in the *Message Delivery* screen (see page 14). You can use the default value or you can change them.
- If you do not change them, each message sent will be delivered to the Phone, Fax, E-mail and/or Pager specified in this screen.
- You MUST click on a check box on the right to enable a delivery method, and at least one MUST be checked.
- The Delivery Attempts field indicates how many times Notifact will attempt to deliver a message if a message is not successfully received. When the message is delivered successfully, no more attempts will be made.
- If the message is not successfully delivered after the specified number of Delivery Attempts, an e-mail will be sent to the Account holder that the User information may need to be changed or updated.
- The Retry Interval is the time period Notifact will wait between attempts to deliver the message.

View & Edit Devices		Install New Device		Last Message Summary		User Information		Credit References	
The purpose of this form is to identify where all messages will be sent. Please check selected delivery methods. You can make changes to the default delivery address/number.									
<b>Type</b>	<b>Address/number</b>						<b>Set</b>		
<a href="#">Phone</a>	<input type="text" value="(555)555-5555"/>						<input type="checkbox"/>		
<a href="#">Fax</a>	<input type="text" value="(555)555-5556"/>	Attn: <input type="text" value="John Doe"/>						<input checked="" type="checkbox"/>	
<a href="#">E-mail</a>	<input type="text" value="jdoe@notifact.com"/>						<input checked="" type="checkbox"/>		
<a href="#">Modem</a>	<input type="text"/>						<input type="checkbox"/>		
<a href="#">Pager</a>	<input type="text"/>	pin <input type="text"/>						<input type="checkbox"/>	
<a href="#">E-mail/XML</a>	<input type="text"/>						<input type="checkbox"/>		
Delivery Attempts	<input type="text" value="3"/>						<input checked="" type="checkbox"/>		
Retry Interval	<input type="text" value="5"/>						<input checked="" type="checkbox"/> min		
<p><b>Number of unsuccessful delivery attempts and the time between them</b> (points to Delivery Attempts)</p> <p><b>AT LEAST ONE of these boxes must be checked to enable delivery</b> (points to Set checkboxes)</p> <p><b>Transmitter messages will be delivered via any of these modes when the SET box is checked</b> (points to Set checkboxes)</p> <p><b>Click here to assign new users during initial installation</b> (points to Assign Users checkbox)</p> <p><b>Please check this box if you would like to assign users to this device. Remember you can always assign users later if needed</b> (points to Assign Users checkbox)</p> <p><input checked="" type="checkbox"/> - Required field</p>									
<input type="button" value="Submit"/>					<input type="button" value="Reset"/>				

View & Edit Devices		Install New Device		Last Message Summary		Manage All Deliveries		User Information		Credit References	
Device Info		Message Delivery		Message History		Heartbeat History		Assign Users			
<b>Location:</b>		<i>ABC Company, 123 Main Street, Main City, NJ, 00000</i>									
<b>Equipment:</b>		Manufacturer: Model: Serial Number: Equipment Name:									
<b>Contact:</b>		Name: <i>John Doe</i> Phone: <i>(555)555-5555</i>									
<b>Device ID:</b>		210									
<b>Device model:</b>		AC-1									
<input type="button" value="Edit Device Location"/>											

[View & Edit Devices](#)
[Install New Device](#)
[Last Message Summary](#)
[Manage All Deliveries](#)
[User Information](#)
[Credit References](#)

[Device Info](#)
[Message Delivery](#)
[Message History](#)
[Heartbeat History](#)
[Assign Users](#)

In order to assign a user to your device, you must know their Member ID.

Users can be assigned for each device with the following rights:

1. FULL RIGHTS: user has the ability to change delivery methods, message descriptions and other device information.
2. READ ONLY: user can only view device information - cannot make any changes.

Please note that if you assign a different user to accept payment responsibility for a device, the change does not take effect until that user confirms this responsibility by responding to an email that will be automatically sent to them from Notifact.

Until this user confirms payment responsibility and his credit has been approved, the owner remains responsible for all Notifact invoices. You will notice a  'square' around the "pays monthly fees" button designating the user you have assigned payment responsibility. The button for the current invoice payer remains selected until new user accepts payment responsibility.

**Device ID # 210**

Assigned Users	Member Id	Pays monthly fees	Rights	Remove User
John Doe	000	<input checked="" type="checkbox"/>	Owner	

The new user that you plan to assign to this device *must* have a Notifact Member Id.

If this person is not a Notifact User, he/she must "Open An Account" and you to have to obtain his/her new Notifact Member Id.

**Assign new user:**

Member Id:

Rights:

Pays bill:

*check if you want new user to pay monthly bill*

You must know the Member ID of the user you wish to assign here. If this user does not have a Member ID & Password, he/she can obtain one by "Opening An Account" on the Notifact Home Page.

**Types of Users**

- FULL RIGHTS: this user will be able to make changes to deliver methods, message descriptions and other device information.
- READ ONLY: can only view device information and make no changes.
- PAYS MONTHLY BILL: As an owner, you can assign someone else to pay the monthly fees, that user must have an approved credit account with Notifact. The owner remains ultimately responsible for monthly fees if the new users does not pay the bill or does not reply to an automatic email sent from Notifact acknowledging payment responsibilities.

[View & Edit Devices](#)
[Install New Device](#)
[Last Message Summary](#)
[Manage All Deliveries](#)
[User Information](#)
[Credit References](#)

These are devices already installed - select one to see more detail or modify settings.  
**'Copy'** installs an additional device with the same location and message delivery details.  
**'Remove'** removes the device and its messages.  
**'Replace'** allows a new device to be swapped into this one's location.  
**'Change Status'** allows to deactivate/reactivate a device.

**\*\*Remove, Copy, Replace and Change Status functionality is available for device Owners only.\*\***

Search by:

Dev. ID	Location	Address	City	Remove Device	Copy Device	Replace Device	Change Status
99	<a href="#">BUILDING CONTROLS, INC / Chiller #1</a>	Some Street	Some city	<a href="#">Remove</a>	<a href="#">Copy</a>	<a href="#">Replace</a>	<a href="#">Deactivate</a>
794★	<a href="#">Notifact / RTU-1</a>	Some street	Some city	<a href="#">Remove</a>	<a href="#">Copy</a>	<a href="#">Replace</a>	<a href="#">Deactivate</a>

**NOTE: Only the owner of a device can Copy, Replace or Remove the device. In the example above, notice that there are no links under Copy, Remove and Replace next to Device ID 575.**

From the **“Device Info”** screen you can view the Owner of the Notifact device by clicking on the **“View Owner”** Tab. See Below:

[View & Edit Devices](#)
[Install New Device](#)
[Last Message Summary](#)
[Manage All Deliveries](#)
[User Information](#)
[Credit References](#)

[Device Info](#)
[Message Delivery](#)
[Message History](#)
[Heartbeat History](#)
[View Owner](#)

**Location:** ABC Company, 123 Main Street, Anytown, NJ, 07000  
**Equipment:** Manufacturer: ACME  
 Model: 2000DX  
 Serial Number: 999999  
 Equipment Name: RTU #1  
**Contact:** Name: 555-555-5556  
 Phone: (555)555-5555  
**Device ID:** 1129  
**Device model:** AH-1

**Click here to View Owner**

**\*\* The owner of this device may have limited available functionality for you \*\***

This will bring you to the Owner screen shown below. You can contact the owner via email by clicking **“Click here to send email to Owner”**

[View & Edit Devices](#)
[Install New Device](#)
[Last Message Summary](#)
[Manage All Deliveries](#)
[User Information](#)
[Credit References](#)

[Device Info](#)
[Message Delivery](#)
[Message History](#)
[Heartbeat History](#)
[View Owner](#)

The owner of device 1129 is:

John Doe  
 123 Main Street, Anytown, NJ, 07000

(555)555-5556  
 jdoe@abc.com

Click [here](#) to email the owner.

## Transmitter is now included in the Device Summary

- You will now return to the Device Summary screen as shown below.
- The basic information on your transmitter will appear.
- If the Information is not correct, click on the unit under Location filed then click Edit Device Location (see screen on page 13) *Edit Device Location* to make changes.



These are devices already installed - select one to see more detail or modify settings. 'Copy' installs an additional device with the same location and message delivery details. 'Remove' removes the device and its messages. 'Replace' allows a new device to be swapped into this one's location. 'Change Status' allows to deactivate/reactivate a device.

**\*\*Remove, Copy, Replace and Change Status functionality is available for device Owners only.\*\***

Search by:

Dev. ID	Location	Address	City	Remove Device	Copy Device	Replace Device	Change Status
210	<a href="#">Notifact server room /</a>	20 New Dutch Lane	Fairfield	<a href="#">Remove</a>	<a href="#">Copy</a>	<a href="#">Replace</a>	<a href="#">Deactivate</a>

 Click on this field to see the messages and detailed information for this transmitter

★ - The appearance of this symbol next to the Device ID indicates the Device failed to report (heartbeat) in for more than 24 hours.



Scroll bars are used when the number of devices exceeds one screen

## Change Status

- Click on *Remove* to remove this device from this location.
- Click on *Copy* to copy all of the delivery methods for this device to another device.
- Click *Replace* to replace a new device with this one, keeping the same delivery methods

## Device Information

- Clicking on the *Location* field (shown above) will bring up the *Device Information* screen.
- A summary of the information which was entered in the *New Device Location* appears. If any of the information is not correct, click on the button *Edit Device Location* to make changes.
- Click on the menu tab *Message Delivery* to edit message descriptions and to select where each type of message will be delivered. If any of the information is not correct, click on the button *Edit Device Location* to make changes.
- Click on the menu tab *Message Delivery* to edit message descriptions and to select where each type of message will be delivered.

# Configuring & Editing Device Messaging

## Device Messages

- Clicking on the menu item *Message Delivery* will bring up the *Device Messages* screen (see top of page 14).
- Each unit comes with predefined default messages. The description of the message can be changed for your specific application. Click on any field in the *Description* column to change it.
- Each specific message can be configured to be sent to different addresses with different delivery methods.

### Last 3 messages

Message ID	Message Date	Message Description
5062	3/15/02 08:01:30	<a href="#">Service Button</a>
5062	3/14/02 15:00:31	<a href="#">Service Button</a>
5062	3/14/02 08:03:26	<a href="#">Service Button</a>

[more...](#)

### Last Heartbeat

Date	Signal Strength	Pending Problem	Battery	Compressor cycles	Compressor Minutes	Fan Minutes
3/15/02 00:47:02	7	No	OK	0	0	0

[more...](#)

## Message Information

- The above screen will list the *Last 3 Messages* sent by the Notifact device.
- To view the message delivery method and address, click on the Message Delivery link
- To view the last 100 messages sent by the Notifact device, click on *more* under *Last 3 messages* or the *Message History* tab.
- The same is true for the *Last Heartbeat*, you can also view Heartbeat messages for the last 90 days by clicking on *more* or the *Heartbeat History* tab.

[View & Edit Devices](#)
[Install New Device](#)
[Last Message Summary](#)
[Manage All Deliveries](#)
[User Information](#)
[Credit References](#)

[Device Info](#)
[Message Delivery](#)
[Message History](#)
[Heartbeat History](#)
[Assign Users](#)

Click on the button to RESTORE ALL messages descriptions to their defaults [Restore All](#)

This is a list of message deliveries for:

Device Id: 210  
 Located at: ABC Company /

Description	Delivery Method	Delivery Address	Edit Delivery Method	Delete Delivery Method	Add Delivery Method	Edit Deliv. Detail
<a href="#">*Unit Failed to Report Heartbeat</a>	E-MAIL	<a href="mailto:jdoe@abcompany.com">jdoe@abcompany.com</a>	<a href="#">Edit</a>	<a href="#">Delete</a>	<a href="#">Add</a>	<a href="#">Edit</a>
<a href="#">Air Flow without Fan</a>	E-MAIL	<a href="mailto:jdoe@abcompany.com">jdoe@abcompany.com</a>	<a href="#">Edit</a>	<a href="#">Delete</a>	<a href="#">Add</a>	<a href="#">Edit</a>
<a href="#">Aux 1 Input Activated</a>	E-MAIL	<a href="mailto:jdoe@abcompany.com">jdoe@abcompany.com</a>	<a href="#">Edit</a>	<a href="#">Delete</a>	<a href="#">Add</a>	<a href="#">Edit</a>
<a href="#">Aux 2 Input Activated</a>	E-MAIL	<a href="mailto:jdoe@abcompany.com">jdoe@abcompany.com</a>	<a href="#">Edit</a>	<a href="#">Delete</a>	<a href="#">Add</a>	<a href="#">Edit</a>
<a href="#">Aux Unit Link Trouble</a>	E-MAIL	<a href="mailto:jdoe@abcompany.com">jdoe@abcompany.com</a>	<a href="#">Edit</a>	<a href="#">Delete</a>	<a href="#">Add</a>	<a href="#">Edit</a>
<a href="#">Compressor Running without Fan</a>	E-MAIL	<a href="mailto:jdoe@abcompany.com">jdoe@abcompany.com</a>	<a href="#">Edit</a>	<a href="#">Delete</a>	<a href="#">Add</a>	<a href="#">Edit</a>
<a href="#">Compressor Short Cycle</a>	E-MAIL	<a href="mailto:jdoe@abcompany.com">jdoe@abcompany.com</a>	<a href="#">Edit</a>	<a href="#">Delete</a>	<a href="#">Add</a>	<a href="#">Edit</a>

↑ ↑ ↑ ↑

↓ To make any changes you must first click on EDIT, DELETE, ADD, or EDIT DELIVERY DETAIL

When you click “Edit” under “Edit Delivery Method” you will be brought this screen

[View & Edit Devices](#)
[Install New Device](#)
[Last Message Summary](#)
[Manage All Deliveries](#)
[User Information](#)
[Credit References](#)

[Device Info](#)
[Message Delivery](#)
[Message History](#)
[Heartbeat History](#)
[Assign Users](#)

This is editable information about a message delivery address.  
 Delivery addresses can be changed only to addresses of the same type (e.g. email to email).

**Important:** This screen allows you to edit the following delivery method for the specific message, or all messages for device # 210, or for all messages on all your devices.

- Edit delivery method for message **Service Button** only
- Edit delivery method for all messages for device # 210  
 Located at **ABC Company /**
- Edit delivery method for all devices

Select this option to change one message only

Select this option to change all messages for this device

Select this option to change all messages for all devices for a User

Old Delivery Address: (555)555-5555

Attn: John Doe

New Delivery Address:

Attn:

[Submit](#) [Go Back](#)

## Custom Messages

- To change the message description to a custom message, click on the message description link (shown in first column of screen on previous page)
- This screen allows you to change the message description for a single delivery method or apply the change to all delivery methods for that message (see screen below).



**Important:** This screen allows you to customize the alarm message description.

- Change message description for this email delivery only.
- Change message description for all **Chiller Shut-down** for device # 210 located at **ABC Company / RTU# 1**

For Device Id: 210  
Default Message: High Refrigerant Pressure  
Old Custom Message: Chiller Shut-down  
New Custom Message:   restore default



## Edit Delivery Detail

- By clicking on *Edit Delivery Detail* (see previous page) you can make changes to the default subject information of a fax or email and the name of the person receiving the fax, as well as the delivery attempts and retry interval for the alarm delivery attempt.
- Clicking “edit” in the *Edit Delivery Detail* column next to an email address allows you to change the subject of the email and the number of delivery attempts and the retry interval (see below).



This screen allows you to change the default subject, to name( fax), number of delivery attempts and retry intervals.

For: ABC Company /  
Default Message: Service Button  
Custom Message: Service Button

Fax number (555)555-5555

Subject   
To Name   
Delivery Attempts    
Retry Interval  min

- Required field



## View Last Message Summary

- It is now possible to view a list of the last messages (if any) received from all of your devices by clicking on the *Last Message Summary* tab at the top of the screen
- You can sort these messages by device ID or message date by clicking on either of those links in the table header bar



This is last message device summary.

<u>Dev ID</u>	<u>Location</u>	<u>Msg ID</u>	<u>Message Date</u>	<u>Description</u>
96	<a href="#">Heat-Timer Engeneering /</a>	5036	3/15/02 11:45:25	<a href="#">Input 4 Activated</a>
210	<a href="#">ABC Company /</a>	5062	3/15/02 08:01:30	<a href="#">Service Button</a>

## Last Message Summary Sort Screen:



This is last message device summary.



<u>Dev ID</u>	<u>Location</u>	<u>Msg ID</u>	<u>Message Date</u>	<u>Description</u>
10	<a href="#">Heat-Timer Service / Tank1</a>	5659	3/9/01 15:28:55	<a href="#">Service Button</a>
120	<a href="#">Heat-Timer Corp. / Temperature Monitor</a>	5026	3/14/01 08:26:07	<a href="#">Temperature over 70 degrees</a>
123	<a href="#">Heat-Timer Server Room / Lennox</a>	5020	2/12/01 15:31:17	<a href="#">High Temperature Alarm</a>
140	<a href="#">ABC Company / RTU-4</a>	5030	12/12/00 15:50:21	<a href="#">Power Loss</a>
178	<a href="#">Notifact Server Room / Computer Room</a>	5062	11/8/00 14:51:26	<a href="#">Service Button</a>
189	<a href="#">XYZ Corp. / Water tretment</a>	5044	1/5/01 16:25:05	<a href="#">Power Loss</a>
206	<a href="#">Notifact Corp. / RTU1</a>	5020	7/12/00 09:02:19	<a href="#">Condensate Spill</a>



## Manage All Deliveries

- By clicking on “Manage All Deliveries” you are able make changes (add, delete or edit) to all delivery methods for all of your devices.
- You can only make changes to devices to which you have FULL RIGHTS.
- If you have only one delivery method in your message delivery table, you will not be able to delete it.
- PLEASE NOTE: Changes made from this screen will affect all of your Notifact devices.



This screen allows you to view the delivery addresses of all your devices.

Changes may be made by clicking Edit or Delete links next to appropriate delivery address. You may also add a new delivery method to all messages for all your devices. To do so, click on *Add New Delivery* button.

**Important:** any changes made from this screen will affect *all* devices that you own and/or devices that you are assigned to with Full Rights.

Add New Delivery

Delivery Method	Delivery Address	Edit Delivery Address	Delete Delivery Address
E-MAIL	<a href="mailto:jdoe@abcompany.com">jdoe@abcompany.com</a>	<a href="#">Edit</a>	<a href="#">Delete</a>
PHONE	<a href="tel:(555)555-5555">(555)555-5555</a>	<a href="#">Edit</a>	<a href="#">Delete</a>
FAX	<a href="tel:(555)555-5555"> (555)555-5555 attn. John Doe</a>	<a href="#">Edit</a>	<a href="#">Delete</a>

- Since you are changing the delivery address across all of your devices at once, this process may take a few moments.
- You will be prompted with the screen below, refresh your screen.
- The change will now be shown in the screen above.



**Processing changes of device message deliveries is not finished.  
Please wait couple minutes and press refresh button.**

Refresh

## De-Activating Your NOTIFACT Device

- Removing a device from website WILL NOT stop billing.
- You can stop billing and cause your Notifact device to stop communicating only by deactivating it.
- The history of alarms and heartbeats will be preserved.
- To deactivate the device, click on deactivate in the “Change Status” column of the *View and Edit Devices* screen (see below).
- You should deactivate the device when it is going to be out of service for at least three months since you will incur a reactivation fee.
- When the device is deactivated, the device status will change to *Re-Activate* in red in the “Change Status” column.
- Only the Owner is able to deactivate or reactivate the device.



These are devices already installed - select one to see more detail or modify settings.  
'Copy' installs an additional device with the same location and message delivery details.  
'Remove' removes the device and its messages.  
'Replace' allows a new device to be swapped into this one's location.  
'Change Status' allows to deactivate/reactivate a device.

**\*\*Remove, Copy, Replace and Change Status functionality is available for device Owners only.\*\***

Search by:

Dev. ID	Location	Address	City	Remove Device	Copy Device	Replace Device	Change Status
96	<a href="#">ABC Company /</a>	123 Main Street	Anvtown	<a href="#">Remove</a>	<a href="#">Copy</a>	<a href="#">Replace</a>	<a href="#">Deactivate</a>

[Click here to de-activate](#)

**Confirm device to be deactivated from the screen below:**



**Important:** This option will cause your device to stop communicating until it is reactivated. The history of alarms, heartbeats, etc. will be preserved at the website. Deactivation will apply to all subunits being monitored by the transceiver. Deactivated devices cannot be "Removed".

Billing for deactivated device will cease on the last day of the month in which it is deactivated and will resume on the first day of the month in which it is reactivated. A reactivation fee will be added to your bill in the month of reactivation.

Reactivation cannot be accomplished unless the transceiver is powered and has signal prior to reactivation at the website.

Device to be deactivated:

96

Located at:

Notifact server room /

Schedule automatic reactivation:

## Re-Activating Your NOTIFACT Device

- The Notifact device can be reactivated after at least a 48 hour waiting period (see next page).
- The device must be powered and have signal before reactivation can occur.
- To reactivate the device, click on *Re-Activate* link in red in the Change Status column on the View and Edit Device screen (see below).



These are devices already installed - select one to see more detail or modify settings. 'Copy' installs an additional device with the same location and message delivery details. 'Remove' removes the device and its messages. 'Replace' allows a new device to be swapped into this one's location. 'Change Status' allows to deactivate/reactivate a device.

**\*\*Remove, Copy, Replace and Change Status functionality is available for device Owners only.\*\***

Search by:

Dev. ID	Location	Address	City	Remove Device	Copy Device	Replace Device	Change Status
96	<a href="#">Notifact server room /</a>	Some Street	Some City	Remove	<a href="#">Copy</a>	<a href="#">Replace</a>	<a href="#">Reactivate</a>

### Reactivation Waiting Period

- You must wait at least 48 hours before reactivating a device.
- If the 48 hour waiting period is not met, you will receive the error message shown below.



Device Id # 96 was deactivated on 3/15/02 1:37:11 PM.  
 Device reactivation request can not be processed within less than 48 hours since deactivation.

Please call the Notifact Customer Service Department at (800) 504-0750 if you have any additional questions.

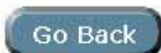

Clicking on the “Reactivate” link brings you to the following screen:



**Important:** This option will resume the communication of your device. Alarm messaging and heartbeat monitoring will resume immediately. The "Device Info" and "Message Delivery" and history profiles in existence prior to deactivation will remain intact.

Billing for this device will resume on the first day of the month in which it is reactivated. A reactivation fee will be added to your bill in the month of reactivation.

Reactivation cannot be accomplished unless the transceiver is powered and has signal prior to reactivation at the website.

Device to be reactivated: 96

Located at: [Notifact server room /](#)



If you have any questions or need assistance in maintaining your Notifact device, please do not hesitate to contact our Technical Support Department at (800) 504-0750 for more information.

## TRANSMITTER SPECIFICATIONS

<b>Input Voltage</b>	85 - 120 VAC	<b>Enclosure</b>	
<b>Power Consumption</b>	15 VA	<b>Type</b>	NEMA-4 suitable for outdoor mounting
<b>Battery Backup</b>	9.6 VDC NICAD	<b>Dimensions</b>	7 1/8"W x 9 5/8"H x 3 1/2"D (18 x 24.5 x 8.9cm)
<b>Operating Temperature</b>	-40 to 140°F (-40 to 60°C)	<b>Material</b>	UV Resistant Gray Plastic
<b>Storage Temperature</b>	-40 to 160°F (-40 to 70°C)	<b>Knockouts</b>	3 bottom, 3 rear (1/2", 3/4" concentric)
<b>Radio</b>			
<b>Transmit</b>	900- 1800MHz		
<b>Receive</b>	900- 1800MHz		
<b>Output</b>	1.5 Watts		
<b>Antenna</b>	Quad Band GSM Antenna		

### ***Please Note:***

No maintenance is required for the rechargeable battery. If a replacement is required as indicated by a weak/low battery alarm message, replace with Notifact Part #N020007-00. There are no other serviceable parts in the unit. Contact Notifact Customer Service for more information:  
20 New Dutch Lane, Fairfield NJ 07004, Phone: 800-504-0750

### ***IMPORTANT:***

*This device must be installed in accordance with National Electrical Code (NFPA70), local codes and the authorities having jurisdiction. See page 22 of this installation manual for details on locating, mounting and wiring.*

Either configure the transmitter before installation (installation details can be filled in later) or arrange to have someone at the site available after completing the Internet setup. Then the unit can be properly tested and will be ready for use.

# Installation

## Connecting a Remote Antenna

- Remote antenna mounting kit (Part #N018040-KIT) also available. Extension cables are available in 10, 15, 20 and 25 ft increments but we do not recommend more than a 50 ft extension. Please check website or contact Notifact.
- The antenna connections on the enclosure are factory installed to prevent water from entering the enclosure. **DO NOT** change any of these existing connections. Disconnect the standard antenna cable from the radio when installing a remote antenna

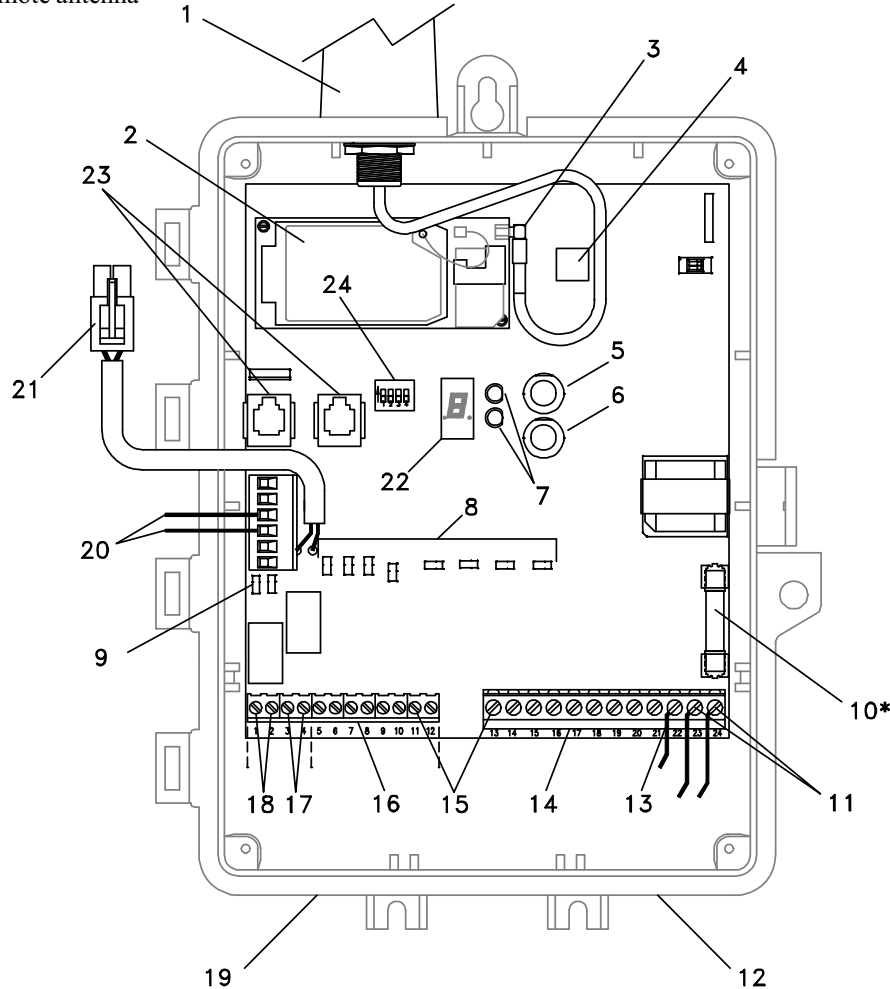









- |  |  |
|--|--|
| <ol style="list-style-type: none"> <li>1. Antenna</li> <li>2. Socket Modem (GSM)</li> <li>3. Antenna cable connection</li> <li>4. Processor module (internal)</li> <li>5. Option button (alarm silence)</li> <li>6. Service button</li> <li>7. Status lights</li> <li>8. Input indication lights</li> <li>9. Relay indication lights</li> <li>10. Fuse, 1 amp, 250 volt, fast blow, 3AG*</li> <li>11. AC Power supply 23, 24 (85-120 VAC, 60 Hz) †</li> <li>12. Use this knockout for Class I leads †</li> <li>13. Device wiring 22 (earth ground)</li> <li>14. Voltage inputs 13-20 (24-120 VAC or 5-48 VDC)</li> </ol> | <ol style="list-style-type: none"> <li>15. Terminal blocks (use 12-18 AWG for connections)</li> <li>16. Dry contact inputs 5-12 (do not apply voltage)</li> <li>17. Relay inputs 3, 4 (not used)</li> <li>18. Relay inputs 1, 2 start/stop relay</li> <li>19. Use this knockout for Class II leads †</li> <li>20. DC power supply connection (12 or 24 VDC)</li> <li>21. Battery pack connector (not connected in DC-powered installations)</li> <li>22. Signal strength (LED) indicator (0-9=signal strength, F=service mode)</li> <li>23. Modbus® RS-485 RJ11 communication ports or factory test ports</li> <li>24. DIP switches; see Section 2.10</li> </ol> |
|--|--|

\* A blown fuse usually indicates a problem that needs to be corrected. Do not replace the fuse without identifying and correcting the problem.

† Never mix Class I and Class II leads. Install signal leads and AC or DC power conductors in separate raceways, cables or conduit. Always follow the National Electrical Code (NEC) and applicable local codes.

## STATUS LIGHTS

Yellow		OFF	<b>No Notifact Service Available</b>
Green		OFF	
.....			
Yellow		FLASHING Once/Second	<b>Service Available, Ready to Transmit</b>
Green		OFF	
.....			
Yellow		FLASHING RAPIDLY	<b>Transmitting Message</b>
Green		FLASHES	
.....			
Yellow		FLASHING AT ONCE/SEC AGAIN	<b>Successful Transmission</b>
Green		OFF	

### Startup Procedure

- Take the transmitter to the area where the equipment to be monitored is located.
- The transmitter will be able to send messages in locations where GSM cell phones will work. If the equipment is in an area where an GSM cell phone can not get a signal, it is likely the transmitter will not be able to get a signal either
- Plug in the battery pack into the battery pack connector (see Pg 22).
- The transmitter will begin a startup routine. The startup time will vary but may last up to several minutes as the transmitter establishes a connection to a cell site and registers a message.
- During the startup routines, the Signal Strength Indicator display segments will rotate. When transmission has established connection to a cell site, the Signal Strength Indicator Display will flash displaying the cell signal strength (Range 0 - 9). The yellow status light will be flashing.
- The transmitter will transmit a message to the Notifact center requesting activation. During transmission, the green status light will flash.
- Once the transmission is activated, the Signal Strength Indicator Display will remain solid.

### IMPORTANT:

If this transmitter has not been configured previously, **DO NOT** leave the site without recording the Device ID number. Without this number, the device can not be configured at the web site.

### Checking Cell Coverage

- Once the startup procedure is complete, the Signal Strength Indicator display will show the cell signal strength the transmitter registers at its current location.
- The cell signal strength can range from 0 to 9.
- The higher the signal strength number, the better the signal.
- A signal strength less than 3 will not provide reliable message transmission. An outside wired antenna may be required.

### Location

- The transmitter can be located either indoors or outside.
- Walk around the equipment or the equipment room with the transmitter powered by the battery pack.
- Note: Battery will display signal for 5 - 15 minutes before it goes into a "sleep" mode which displays a decimal point. Simply unplug then reconnect to continue on battery power to determine final location
- Place it in several sample mounting locations and check the signal strength.
- Once the mounting location with the strongest (highest number) signal strength is found, remove the battery pack connection.

## Mounting

- Choose a surface which is flat and strong enough to hold the transmitter.
- Antenna must clear the top of the equipment by 2 inches minimum.
- The temperature range the transmitter will experience should not exceed -40°F to 160°F (-40°C to 70°C).
- The transmitter enclosure has one keyhole mounting tab extending from the top of it and two mounting tabs extending underneath. Use all three tabs to secure the unit.
- **DO NOT** drill any holes into or through the enclosure.
  
- Each transmitter model has different functions for the 4 sets of switch inputs and the 4 sets of power inputs (see pg.22). Each input is labeled for the particular model. The red lights above the inputs show the status of the particular input.
- To set up the dip switch and wire the inputs, see the model specific label inside the transmitter.
- Filed wiring to the inputs must be a minimum of 18 AWG and maximum of 12 AWG.

## Record Equipment Information

Either fill in the enclosed MONITORED EQUIPMENT I.D. CARD with the fields described below or call your home office with the following information:

- The *Location Name* for the piece of equipment being monitored.
- The exact *Street Address*, and the *City*, *State*, and *Zip* code where the transmitter is located.
- The *Local Contact Phone* and *Name* should be the phone number and name of the person(s) who would need to be contacted to gain access to this transmitter.
- The *Device ID* number located on the black protective cover inside the transmitter. This is also preprinted on the INSTALLATION card.
- The *Equipment Name* for the piece of equipment being monitored. Try to be as specific as possible, especially if there are multiple pieces of equipment which will have transmitters installed at a single site. Possible examples are North Roof Top AC, Boiler-5, Store A Refrigeration 3, etc.
- The *Equipment Manufacturer*, *Model*, and *Serial Number*. This information should be sufficient to identify repair or replacement parts before a service person is dispatched to the site.
- Before leaving the site, either use the information collected to set up *Notifact* to recognize the transmitter or have someone else with Internet access do it.

## Testing

- Note: that while the following test is recommended, the transmitter will send out a Heartbeat message every night. Therefore, it is possible to wait until the next morning to determine if the transmitter sent out a message.
- The yellow status light should be flashing once per second (see Pg 23). This indicates the transmitter registers service, is available and is ready to send. The green status light should not be on.
- Press the *Service Button* and then release it.
- The green light will flash several times. When the green light flashes quickly for approximately 2 seconds, the message has been sent.
- After the message has been successfully sent, the green light will once again be off, and the yellow light should flash every second showing the transmitter is ready to send another message.
- Check, the *Notifact* website to be sure the message was received.
- If the message does not go through after the first few attempts, the yellow light will begin flashing rapidly, indication at the unit is holding a message.
- After about 5 minutes, the green light will again begin to flash indicating an attempt to transmit.
- This cycle will continue until the message is sent.

## Check the Transmitter

- Check that the service button message will be sent to the appropriate address with the appropriate delivery method.
- Have someone at the transmitter site press the *Service Button* (see pg. 22). If you do not have someone to press the *Service Button*, you can wait until the next morning and check the *Heartbeat*.
- The *Device Information* screen will show the message that the service button has been pressed.
- Also check that all the other appropriate messages were received. A sample e-mail message appears below. Make sure the appropriate individuals were paged, that the appropriate faxes were sent, and the appropriate phone calls were made.

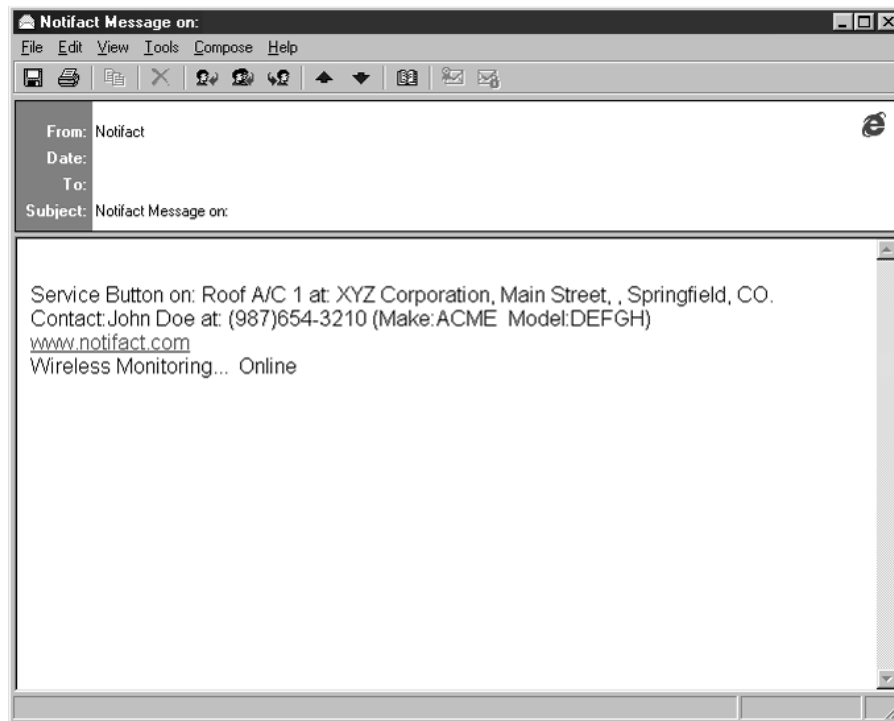

## Check the messages

- Confirm the equipment information is correct including the name, model, make and address.
- Confirm the contact information is correct. The contact information should be the name and phone number of the individual(s) who can provide access to the equipment.

# **NOTIFACT System Check List**

## **Included in Package from NOTIFACT**

- (1) Notifact Device
- (1) Equipment ID Card
- (1) Installation and Operating Manual

## **Checking Cellular Coverage**

- Connect Battery (unit will Power-up)
- Signal Strength Display will appear
- If Signal Strength does not appear after 5 minutes, contact Notifact Technical Support
- Walk around equipment area to find strongest cell signal
- A steady Signal Strength of at least 3 indicates adequate Cellular Coverage
- If good cellular coverage is attained, disconnect battery and begin installation on equipment

## **Configure Notifact Device on the Web Site**

- See instructions on this manual

## **Physically Install/Wire the Notifact device to the Equipment being monitored**

- Refer to wiring instructions on the label inside the Notifact enclosure as well as Page 5 of this manual.
- Record location information on the Equipment ID Card

## **Checking the Transmitter**

- Once installation is complete, press the Service Button to verify a complete loop of the communication system and confirm message is received

# Notes



20 New Dutch Lane, Fairfield, NJ 07004  
800-504-0750 Fax 800-359-0826  
[www.notifact.com](http://www.notifact.com)

THESE PRODUCTS ARE NOT SUITABLE FOR USE, AND ARE NOT INTENDED TO BE USED, FOR FIRE OR SMOKE DETECTION, SECURITY, EMERGENCY OR LIFE SUPPORT APPLICATIONS.

THESE PRODUCTS ARE INTENDED TO BE INSTALLED BY PROFESSIONAL INSTALLERS ONLY.  
NOTIFACT DISCLAIMS ANY LIABILITY FOR DAMAGES CAUSED BY INCORRECT INSTALLATION OR IMPROPER USE OF THESE PRODUCTS.

COPYRIGHT © 2007 BY NOTIFACT. ALL RIGHTS RESERVED

059201-00  
Rev F 07/17/07